



A

ONDOKUZ MAYIS UNIVERSITY INTERNATIONAL STUDENT EXAM

May 12, 2018

NAME	:
SURNAME	:
ID NUMBER	:
SIGNATURE	:	SEAT NUMBER:

IMPORTANT INFORMATION

- This booklet includes test questions for international students who wish to study in certain Turkish universities.
The number of questions are as follows:

Mathematics	40
Basic Learning Skills	40
- This is an "A" type booklet. Please mark the type of your booklet on the answer sheet as shown below, and make sure it has been confirmed by the exam supervisor.
If you do not code the booklet type correctly on the answer sheet, your exam will be invalid.
- You have **120 minutes** to complete the exam.
- Each question has only one correct answer. Multiple selections will be considered as incorrect.
- The answers to the questions given in the booklet should be marked by pencil on the answer sheet provided with this booklet. Please use a pencil. Do not fold the answer sheet and do not write anything not required on it.
- Inappropriate markings on the answer sheet will not be read by the optical reader. The candidate is responsible for the mistakes incurred by inappropriate markings.**
- Only correct answers will be calculated in this exam. You will not lose any points for incorrect answers.
- Further information about the examination rules are printed on the back cover of this booklet.

TYPE OF THE QUESTION BOOKLET

A ●	B ○
PARAPH	PARAPH

ONDOKUZ MAYIS UNIVERSITY

www.study-apply.com

MATHEMATICS

1.
$$\left. \begin{array}{l} A = 4831.4836 \\ B = 4829.4838 \end{array} \right\} \Rightarrow A - B = ?$$

- A) 7 B) 14 C) 28 D) 34 E) 35

2.
$$2 - \frac{1}{2 - \frac{1}{2 - \frac{1}{x}}} = ?$$

- A) $1 + \frac{x-3}{3x-2}$ B) $1 - \frac{x+3}{3x-2}$
 C) $1 + \frac{x-1}{3x-2}$ D) $1 - \frac{x+1}{3x-2}$
 E) $1 + \frac{2x-1}{3x-2}$

3. Which one of the following is an odd number?

- A) $2^{40} + 7!$ B) $63! - 3^{10}$ C) $0! + 5^{20}$
 D) $4^7 \cdot 3^5 - 8^{14}$ E) $11! - 9!$

4. A, B, C, D are non-empty sets.

If $A \subset B \subset C \subset D$ then,
 what is $[(A \cup B) \cap (C \setminus B)] \cup D$?

- A) C B) \emptyset C) $B \cup D$
 D) $A \setminus C$ E) D

5. $a, b \in \mathbb{R}, \frac{5^{a-b}}{27^{a+b}} = 135 \Rightarrow a^2 - b^2 = ?$

- A) -3 B) -1 C) 0
 D) 1 E) 3

6. If $A = \{\{1\}, 1, 2, \{1, \{2\}\}, \{3\}\}$ then, which one of the following is wrong?

- A) $\{1, \{3\}\} \subset A$ B) $\{1\} \in A$
 C) $\{1, 2\} \in A$ D) $\{2, \{3\}\} \subset A$
 E) $\{1\} \subset A$

7. If $b < 0 < a$ then,

what is $\sqrt{(3a-b)^2} - \sqrt{(b-a)^2} = ?$

A) $2a$ B) $4a$ C) $2a - 2b$

D) $4a - 2b$ E) $-4a + 2b$

8. Let x, y be positive integers and

$$\left. \begin{aligned} P &= \frac{x}{y+2} \\ R &= \frac{x}{y} \\ S &= \frac{x+3}{y} \end{aligned} \right\}$$

. Which of the following ordering is true?

- A) $R < P < S$
 B) $P < S < R$
 C) $P < R < S$
 D) $S < R < P$
 E) $R < S < P$

9. Which one of the following is the solution set

of $\frac{(x^2 + x + 4)(x - 1)}{x^2 - 4} < 0$?

A) $(-\infty, -2) \cup (2, \infty)$ B) $(2, \infty)$

C) $(-2, 2)$ D) $(-\infty, -2) \cup (1, 2)$

E) $(-2, 1) \cup (2, \infty)$

10. How many integers x exist satisfying

$$|x - 2018| = 2018 - x$$

$$|x - 1234| = x - 1234 \quad ?$$

A) 781 B) 782 C) 783

D) 784 E) 785

11. The remainder of the division of the polynomial $P(x) = ax^4 - 2ax^2 + 5x - 2$ by $(x+1)$ is -4 . What is the remainder of the division of $P(x)$ by $(x-1)$?

A) 6 B) 2 C) 0

D) -2 E) -6

12. If $x \neq y$ and $4x + \frac{5}{x} = 4y + \frac{5}{y}$ then, what is $x \cdot y$?

A) $-\frac{5}{4}$ B) $-\frac{5}{2}$ C) -5

D) $\frac{5}{4}$ E) $\frac{5}{2}$

$$13. \frac{x}{z+5} = \frac{y}{x+1} = \frac{z}{y-2} = \frac{3}{5}$$

$$\Rightarrow x+y+z=?$$

- A) 6 B) 10 C) 12 D) 16 E) 20

$$14. x + \frac{1}{y} = 3, y + \frac{1}{x} = 5$$

$$\Rightarrow \frac{x-3y}{3x+y} = ?$$

- A) $-\frac{6}{7}$ B) $-\frac{2}{9}$ C) $-\frac{1}{2}$
 D) $\frac{2}{9}$ E) $\frac{6}{7}$

15. Let a, b be integers and

$$\left. \begin{array}{l} a^2 + 5a - b^2 + 5b = 14 \\ a + b = 2 \end{array} \right\} \Rightarrow b = ?$$

- A) -1 B) 0 C) 1 D) 2 E) 3

16. If x, y are real numbers and

$$2x^2 + y^2 + 2xy - 4x + 4 = 0 \text{ then, what is } x+3y?$$

- A) -8 B) -4 C) 0 D) 4 E) 8

$$17. \binom{4}{0}2^4 + \binom{4}{1}2^3 + \binom{4}{2}2^2 + \binom{4}{3}2^1 + \binom{4}{4}2^0 = ?$$

- A) 2^3 B) 4^3 C) 3^4 D) 3^5 E) 4^4

18. If $z = \frac{9}{2+i} - \frac{33}{4-3i}$ then, what is $im(z)$?

- A) $-\frac{9}{25}$ B) $\frac{54}{25}$ C) $-\frac{42}{25}$
 D) $-\frac{144}{25}$ E) $\frac{222}{25}$

19. What is the smallest three digit number

divisible by $\frac{2}{3}, \frac{7}{9}, \frac{4}{13}$ without a remainder?

- A) 102 B) 108 C) 112
D) 120 E) 124

20. If $f: \mathbb{R} \rightarrow \mathbb{R}$, $f(x) = x^2 - 4$ then, which one of the following is true?

- A) $f^{-1}(x) = \sqrt{x+4}$
B) $f^{-1}(x) = \sqrt{x-4}$
C) $f^{-1}(x) = \sqrt{x} + 4$
D) $f^{-1}(x) = \sqrt{x} - 4$
E) The inverse of the function f does not exist.

21. $f: \mathbb{R} \rightarrow \mathbb{R}$, $g: \mathbb{R} \rightarrow \mathbb{R}$

$$f(x+1) = -2x^4 - 8x^3 - 12x^2 - 8x - 2,$$

$$g(x) = x^3 - 8 \Rightarrow g \circ f(-1) = ?$$

- A) 16 B) 7 C) 0
D) -7 E) -16

22. $0^\circ < x < 90^\circ$,

$$\frac{2 \cdot \cos 22^\circ \cdot \cos 68^\circ - 2 \cdot \sin 22^\circ \cdot \sin 68^\circ}{-\sin 21^\circ \cdot \cos 69^\circ - \sin 69^\circ \cdot \cos 21^\circ} = \frac{\tan x - \tan 27^\circ}{1 + \tan x \cdot \tan 27^\circ}$$

$$\Rightarrow x = ?$$

- A) 9° B) 27° C) 45°
D) 54° E) 81°

23. If the first three terms of an arithmetic sequence are $a-1$, $2a+5$, $5a+1$, respectively, then what is the fifth term of this sequence?

- A) 39 B) 42 C) 46
D) 48 E) 52

24. If the first three terms of a geometric sequence are $(x-3)$, $(2x-3)$, $(4x+3)$, respectively, what is the eighth term of this sequence?

- A) 3^4 B) 3^5 C) 3^6
D) 3^7 E) 3^8

25. $\log_2 x = 5, \log_{\sqrt{3}} y = 4 \Rightarrow x + 2y = ?$

- A) 50 B) 41 C) 22
D) 78 E) 113

26. Let $f(x) = \begin{cases} \frac{3x}{x^2 - 16}, & x \leq 2 \\ \frac{x - 2}{x^2 - 5x + 6}, & x > 2 \end{cases}$.

How many points of discontinuity exist for $f(x)$?

- A) 1 B) 2 C) 3 D) 4 E) 5

27. $\lim_{x \rightarrow \frac{\pi}{2}} \frac{\cos x - \sin 4x}{\cot x} = ?$

- A) -5 B) -3 C) 1
D) 3 E) 5

28. $f: [3, \infty) \rightarrow [-4, \infty)$

$f(x) = x^2 - 5x + 2 \Rightarrow (f^{-1})'(-4) = ?$

- A) -2 B) -1 C) 0
D) 1 E) 2

29. $f(x) = \sin 3x - \tan 2x$

$\Rightarrow \lim_{h \rightarrow 0} \frac{f\left(\frac{\pi}{6} + h\right) - f\left(\frac{\pi}{6}\right)}{h} = ?$

- A) -8 B) -4 C) $-\frac{8}{3}$
D) $-\frac{4}{3}$ E) -1

30. $\int_0^1 \sqrt{x\sqrt{x^3\sqrt{x^5}}} dx = ?$

- A) $\frac{15}{4}$ B) $\frac{8}{23}$ C) $\frac{11}{4}$
D) $\frac{15}{8}$ E) $\frac{23}{8}$

31. If $f''(x) = 5x + 3$, $f'(0) = 5$, $f(0) = -1$ then, what is $f(1)$?

- A) $\frac{13}{3}$ B) $\frac{1}{3}$ C) $-\frac{1}{3}$
 D) $\frac{19}{3}$ E) $-\frac{12}{3}$

32.

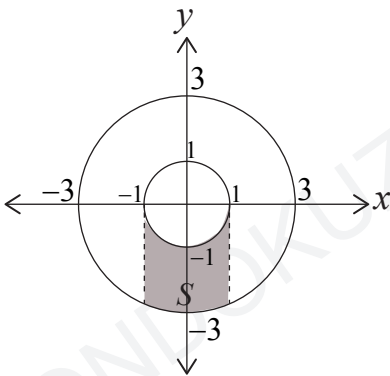

$S = ?$

- A) $S = \int_{-1}^1 (\sqrt{9-x^2} - \sqrt{1-x^2}) dx$
 B) $S = \int_{-1}^1 (\sqrt{9-x^2} + \sqrt{1-x^2}) dx$
 C) $S = \int_{-1}^1 (\sqrt{1-x^2} - \sqrt{9-x^2}) dx$
 D) $S = \int_{-1}^1 (\sqrt{1-x^2} + \sqrt{9-x^2}) dx$
 E) $S = \int_{-1}^1 (\sqrt{1-x^2} - \sqrt{3-x^2}) dx$

33.

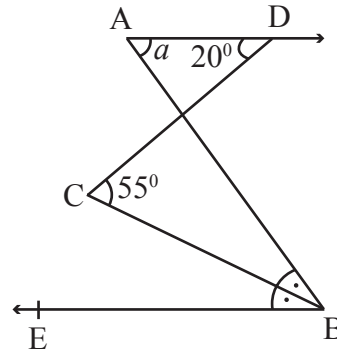

$[AD \parallel [BE$
 $[BC]$, bisector

$m(\widehat{ADC}) = 20^\circ$

$m(\widehat{BCD}) = 55^\circ$

$m(\widehat{BAD}) = a = ?$

- A) 70 B) 65 C) 60
 D) 55 E) 50

34.

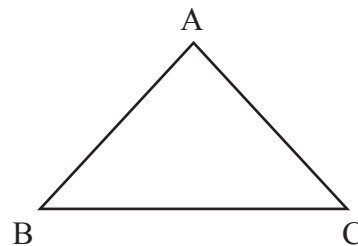

If $|AB| = 7$ cm for the triangle ABC then, what is the smallest integer value of the circumference of ABC?

- A) 13 B) 14 C) 15
 D) 16 E) 17

35.

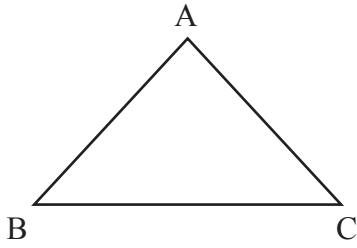

ABC triangle, $m(\hat{A}) > 90^\circ$ and
 $|BC| = a$ cm
 $|AC| = b$ cm
 $|AB| = c$ cm

Which one of the following is always true?

A) $a^2 < b^2 + c^2$ B) $\frac{a}{2} > b + c$

C) $a > 1, b > 0, c > 0$ D) $b > c$

E) $\frac{b+c}{2} < a$

36.

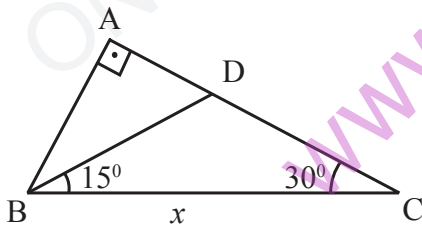

BAC right triangle

$m(\hat{DBC}) = 15^\circ$

$m(\hat{ACB}) = 30^\circ$

$|DC| = 4(\sqrt{3} - 1)$ cm

$|BC| = x = ?$

A) 10 B) 8 C) 6

D) 4 E) 2

37.

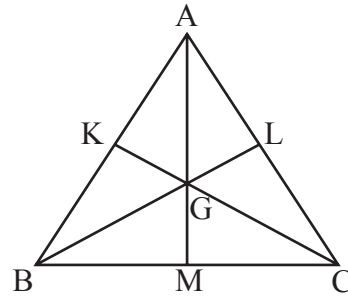

G is the center of gravity of the triangle ABC.

$|AB| = 10\sqrt{2}$ cm

$|GM| = 8$ cm

$|BG| = 6$ cm

$|GC| = ?$

A) 6 B) 8 C) $4\sqrt{6}$

D) $6\sqrt{6}$ E) $8\sqrt{6}$

38.

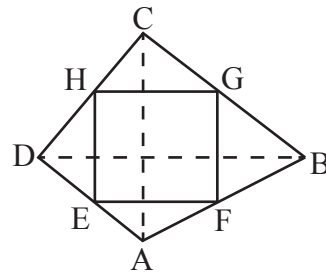

ABCD quadrangle

E, F, G, H midpoints

$|AC| = 17$ cm

$|DB| = 13$ cm

What is the circumference of EFGH?

A) 15 B) 20 C) 24

D) 30 E) 32

39.

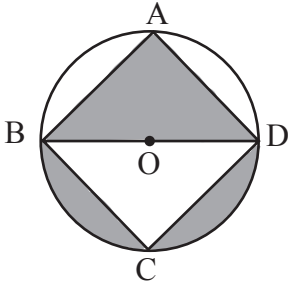

O is the center of the circle, the vertices of the rectangle ABCD are on the circle.

$$|DC| = 12 \text{ cm}$$

$$|AD| = 16 \text{ cm}$$

What is the sum of the shaded areas?

A) 24π B) 32π C) 50π

D) 56π E) 60π

40. Which one of the following is the equation of the line passing through the intersection of the lines

$$d_1 \dots 17x + 13y - 4 = 0$$

$$d_2 \dots 5x - 31y + 2 = 0$$

and the origin?

A) $11x = 9y$ B) $22x = 49y$

C) $3x = 11y$ D) $27x = 49y$

E) $11x = 49y$

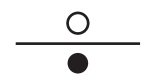

Mathematics Test is completed.

BASIC LEARNING SKILLS

1.  +  = ?

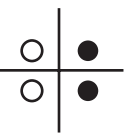
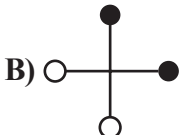
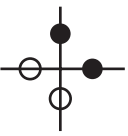
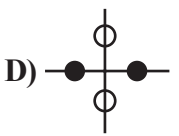
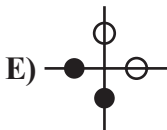
Which one of the following should be replaced in the question mark (?)?

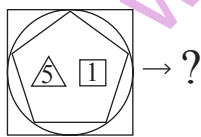

- A)  B) 
- C)  D) 
- E) 

2.  $\rightarrow x^2 + 2y + \frac{1}{z}$,  $\rightarrow \left(2x + \frac{1}{y}\right)^2$

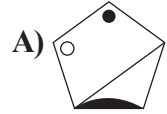
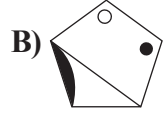
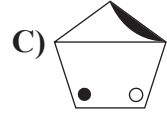
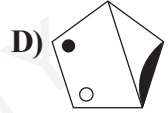

- A) $\frac{1}{121}$ B) 121 C) 222
- D) $\frac{1}{222}$ E) $\frac{1}{12}$

3. Which is the odd one out?

- A)  B) 
- C)  D) 
- E) 

4. [381, 127] [132, ?] [27, 9]

Which one of the following should be replaced in the question mark (?)?

- A) 81 B) 63 C) 44
- D) 33 E) 27

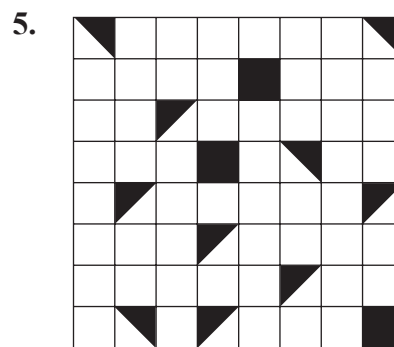

What percentage is painted?

- A) 12,5 B) 15 C) 20
- D) 25 E) 32,5

6. $345 \longrightarrow 17$
 $534 \longrightarrow 19$
 $268 \longrightarrow 20$
 $639 \longrightarrow ?$

Which one of the following should be replaced in the question mark (?)?

- A) 18 B) 25 C) 27
 D) 30 E) 33

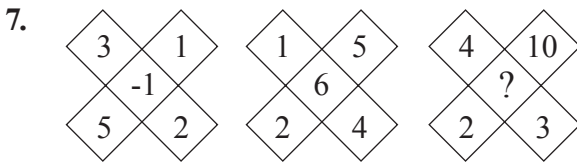

Which one of the following should be replaced in the question mark (?)?

- A) 4 B) 5 C) 6 D) 7 E) 8

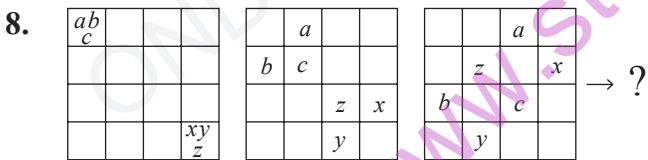

Which one of the following should be replaced in the question mark (?)?

- A)

z		by
ax		c

 B)

ab		c
z		xy

 C)

xy		ac
b		z

 D)

z		ax
by		c

 E)

b		cy
a		xz

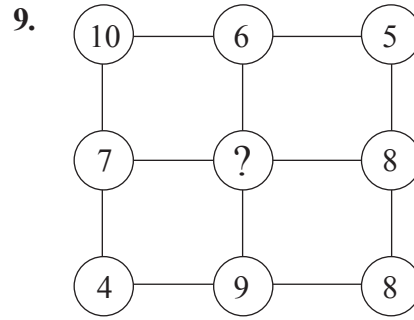

Which one of the following should be replaced in the question mark (?)?

- A) 10 B) 8 C) 6 D) 4 E) 2

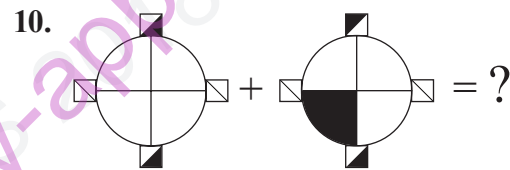

Which one of the following should be replaced in the question mark (?)?

- A) B)
 C) D)
 E)

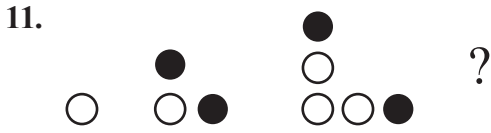

Which one of the following should be replaced in the question mark (?)?

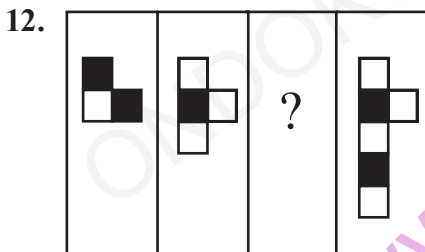
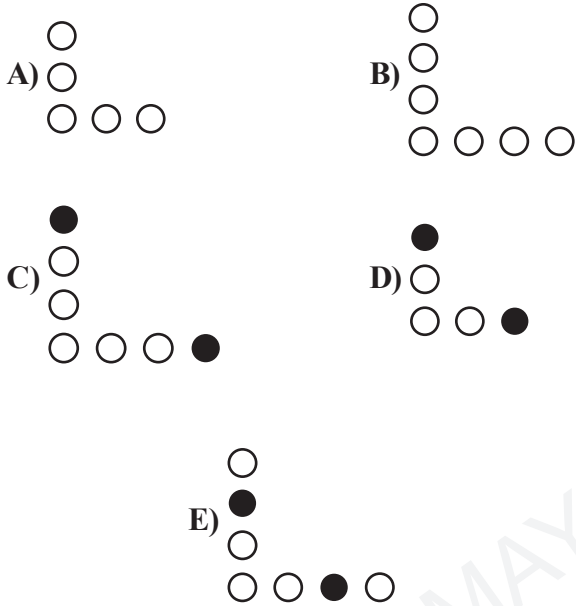

Which one of the following should be replaced in the question mark (?)?

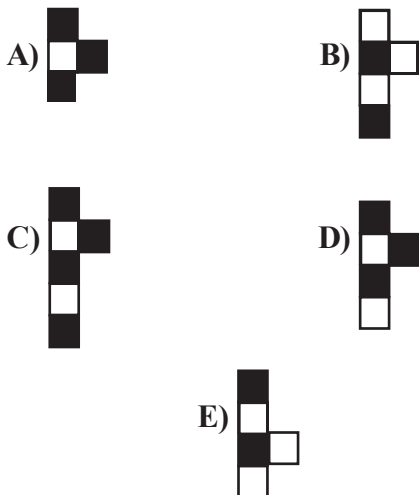

13. $\square 214 = 7$
 $\bigcirc 48 = 32$
 $\triangle 27 = 5$
 $\triangle \bigcirc \square 6754239 = ?$

- A) 7 B) 6 C) 5 D) 4 E) 3



Which one of the following should be replaced in the question mark (?)?

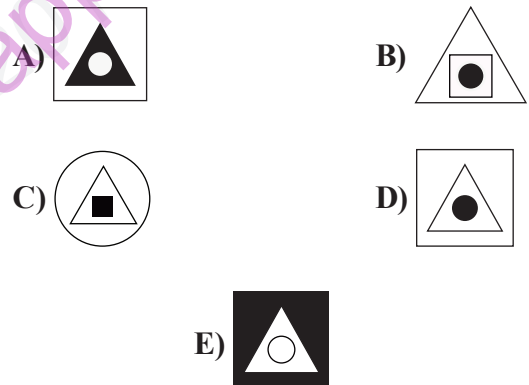

15. $\square + \bigcirc = \triangle \Rightarrow \frac{\triangle + \bigcirc}{\square} = ?$
 $\bigcirc - \square = \square$

- A) 1 B) 2 C) 3 D) 4 E) 5

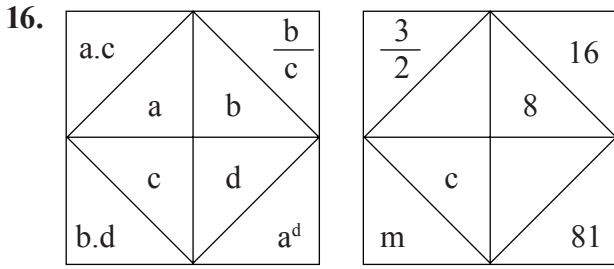

$m.c = ?$

- A) 16 B) 32 C) 64
D) 128 E) 256

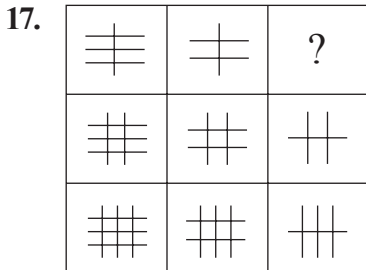

Which one of the following should be replaced in the question mark (?)?

- A) | B) ≡ C) +
D) — E) ≡≡

18. Which is the odd one out?

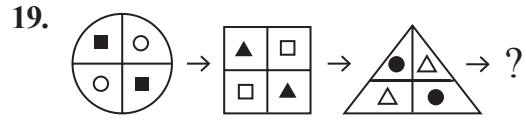
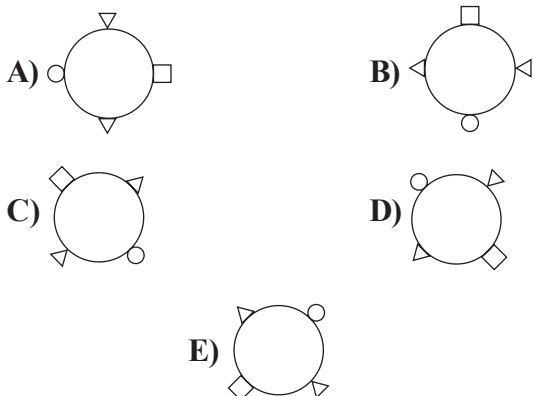

Which one of the following should be replaced in the question mark (?)?

- A)
- B)
- C)
- D)
- E)

20. 342178 → 871432 → 234781 → 187324 → ?

Which one of the following should be replaced in the question mark (?)?

- A) 423817 B) 234871
C) 781243 D) 817432
E) 328714

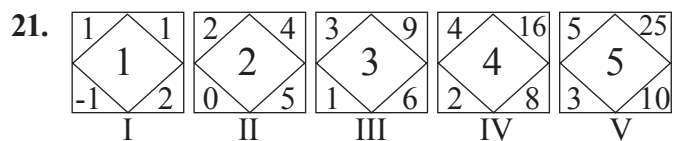

Which shape does not obey the rule?

- A) I B) II C) III D) IV E) V

22. 2 4 10 ? 82 244

Which one of the following should be replaced in the question mark (?)?

- A) 28 B) 30 C) 32
D) 34 E) 36

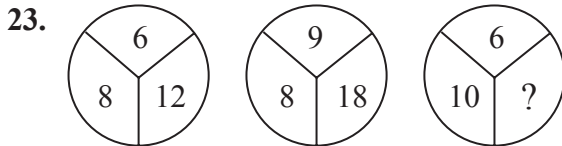

Which one of the following should be replaced in the question mark (?)?

- A) 14 B) 15 C) 16
D) 17 E) 18

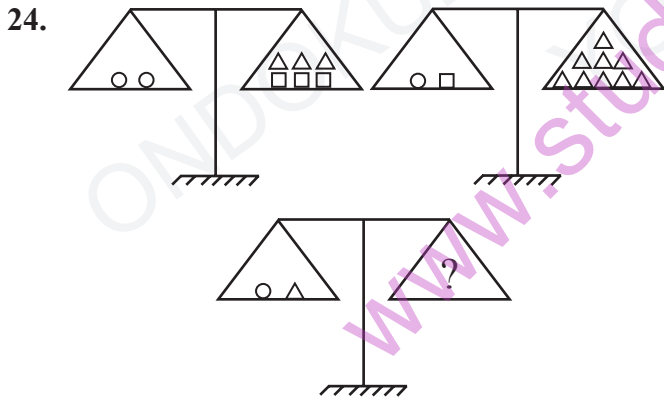

Which one of the following should be replaced in the question mark (?)?

- A) B)
C) D)
E)

25. KEDİ 1537
DİKE 7351
KİDE 1735
EDİK 7153
EKİD 3517
~~~~~                      ~~~~~  
I                              II

DİEK = ?

- A) 3517                      B) 5371  
C) 5317                      D) 7531  
E) 3571

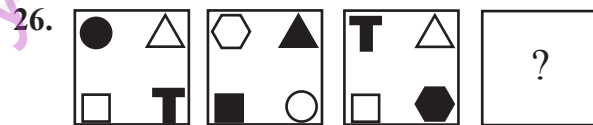

Which one of the following should be replaced in the question mark (?)?

- A)                      B)   
C)                      D)   
E)

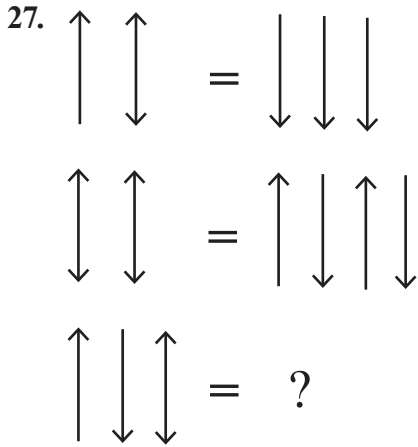

Which one of the following should be replaced in the question mark (?)?

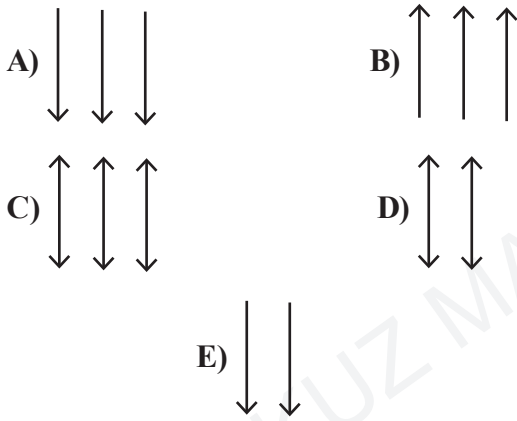

The above pentagon is rotated 108° clockwise. Which one of the following is obtained?

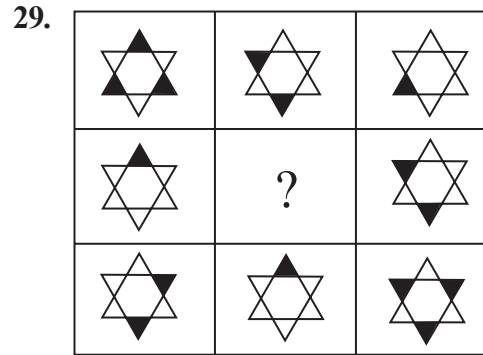
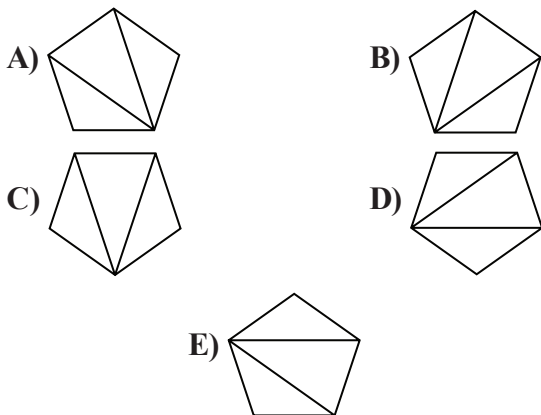

Which one of the following should be replaced in the question mark (?)?

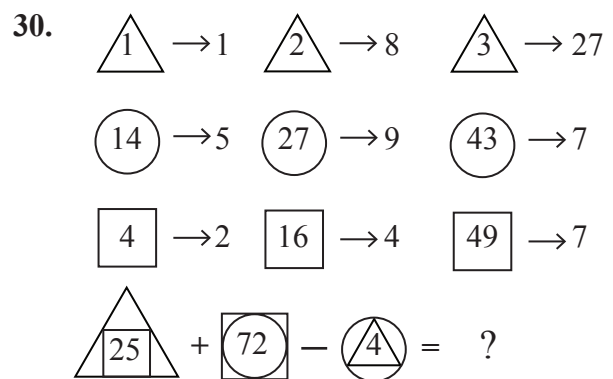
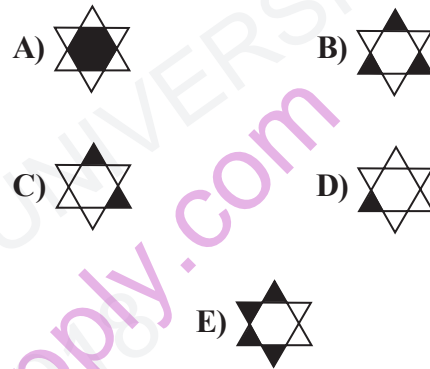

Which one of the following should be replaced in the question mark (?)?

- A) 118                      B) 128                      C) 132  
D) 138                      E) 142



31. 9 6 10 7 15 12 ? 21 37

Which one of the following should be replaced in the question mark (?)?

- A) 9                      B) 15                      C) 18  
D) 20                      E) 24

32.

|    |   |   |    |   |   |
|----|---|---|----|---|---|
| 16 | 5 | 3 | 14 | ? | 5 |
| 22 | 4 | 7 | 20 | 1 | 9 |

Which one of the following should be replaced in the question mark (?)?

- A) 2      B) 4      C) 6      D) 8      E) 10

33.

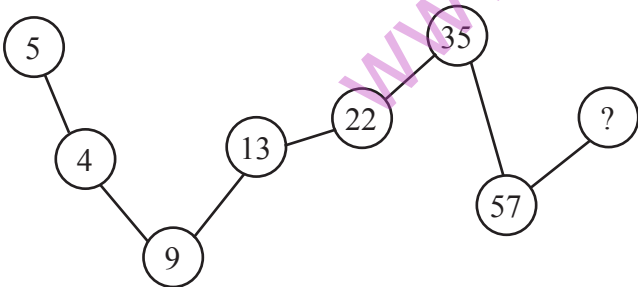

Which one of the following should be replaced in the question mark (?)?

- A) 65                      B) 70                      C) 85  
D) 92                      E) 100

34.  $\begin{matrix} \triangle \\ 2 \end{matrix} + \begin{matrix} \square \\ 3 \end{matrix} = 93$   
 $\begin{matrix} \triangle \\ 2 \end{matrix} + \begin{matrix} \square \\ 4 \end{matrix} = 268$   
 $\begin{matrix} \triangle \\ X \end{matrix} + \begin{matrix} \square \\ 2 \end{matrix} = 34 \Rightarrow X = ?$

- A) 7      B) 6      C) 5      D) 4      E) 3

35.  $3\frac{1}{2}$     $5\frac{1}{4}$    7   ?    $10\frac{1}{2}$     $12\frac{1}{4}$

Which one of the following should be replaced in the question mark (?)?

- A)  $8\frac{1}{4}$                       B)  $8\frac{3}{4}$                       C)  $9\frac{1}{4}$   
D)  $10\frac{1}{2}$                       E)  $10\frac{1}{4}$

36.

|  |  |   |
|--|--|---|
|  |  | ? |
|  |  |   |
|  |  |   |

Which one of the following should be replaced in the question mark (?)?

- A) 
 B) || C) | D) |
| E) |  |

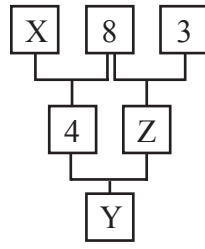
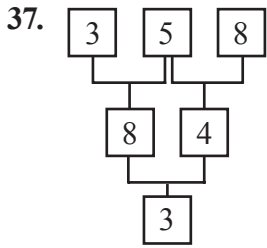

$X + Y + Z = ?$

- A) 5    B) 6    C) 8    D) 12    E) 13

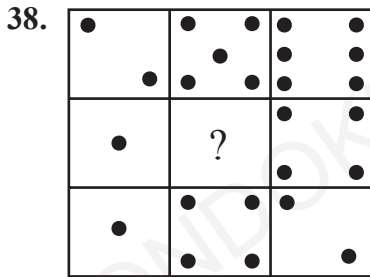

Which one of the following should be replaced in the question mark (?)?

- A)    B)   
 C)    D)   
 E)

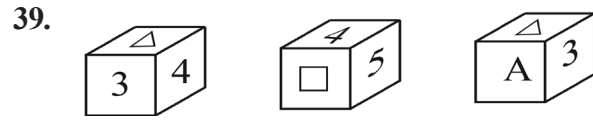

A cube is presented in different positions. Which one of the following is the open form of this cube?

- A)   
 B)   
 C)   
 D)   
 E)

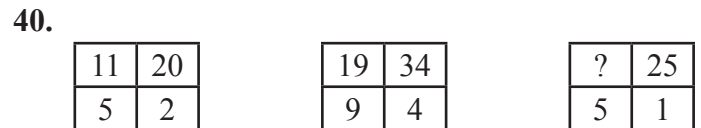

Which one of the following should be replaced in the question mark (?)?

- A) 21    B) 19    C) 15    D) 13    E) 11

ONDOKUZ MAYIS UNIVERSITY

[www.study-apply.com](http://www.study-apply.com)



# A

## EXAMINATION RULES

1. Following materials are prohibited in exam room: Any communication equipments e.g. pagers, walkie-talkies, PDA's, watches with any other functions, weapons, notebooks, books, dictionaries, any electronic device with dictionary function, calculators, calculation charts, compasses, goniometers, rulers and etc. If any candidate enters the exam room with the prohibited materials, his/her name will be recorded and their examinations will be considered invalid.

2. Duration of the exam is **120** minutes. Candidates are allowed to take the exam if they are not late for more than **30** minutes. Candidates are not allowed to leave the exam room in the first **40** minutes and the last **5** minutes of the examination. Candidates who completed the exam or left the examination room will not be allowed to re-enter the examination room. If you complete the exam before the end of the duration you can leave the room after submitting your question booklet and answer sheet. When the end of the examination is announced you must remain seated and may not leave the examination room until all papers are collected by the invigilators.

3. Communicating with the invigilators during the examination is prohibited. Similarly, it is prohibited for the staff to talk to candidates privately. Candidates are not allowed to exchange pencils, erasers, papers etc. during the exam.

4. The exam of any candidate who cheats, attempts to cheat or assists cheating will be considered invalid and his/her identity will be recorded. Invigilators do not have to warn the students about cheating. The candidate is responsible for his/her actions. Answers of the candidates will be examined electronically. If any suspicious case is detected regarding individual or collaborate cheating, the exams of all candidates who participate in this action will be considered invalid. If invigilators report any case of misconduct in the application of the exam or collaborate cheating, OMÜ-YÖS Coordinating Office may decide to consider all of the candidates' exams invalid for that room.

5. All candidates must obey the rules in the exam room. If necessary, your seat may be changed by invigilators. Obeying the rules is of utmost importance for validation of the exam. Identity of any candidate who engages in misconduct and does not heed the invigilator's warning to discontinue the behavior, will be recorded and his/her

examination will be considered invalid.

6. You must fill all the required fields on the answer sheet. Only pencils should be used for marking and writing on the answer sheet. Pens or ball point pens should not be used. All the answers should be marked on the answer sheet. Answers marked on the question booklet will be considered invalid.

7. Please check your question booklet for missing pages or typos after receiving it. If there are any missing pages or typos on your booklet, please immediately request for the change of the booklet from the head invigilator. You should also check if the booklet type written on the cover page is the same as the booklet type written on every page of the booklet. If you find any difference, please request a new booklet from the head invigilator. If you realise any difference about booklet types after you start the examination, request a new booklet of the same type you have answered. Please mark your booklet type on the "Question Booklet Type" area on the answer sheet. Booklet type you have marked will be checked by the invigilators and initialed with a pen. If the related area is not initialed, your answer sheet will not be evaluated. If there is difference between the booklet types that you have marked and the invigilator has marked, evaluation will be based on the one that is marked by invigilators.

8. Please write your name, surname and candidate number on the question booklet before starting to answer the questions. All the question booklets and answer sheets will be collected and examined at the end of the examination. In case of missing pages, examination of the related candidate will be considered invalid.

9. You can use the spaces on the question booklet for calculation.

10. Smoking (cigarettes, pipes, cigars etc.) is not allowed during the examination for both candidates and the staff.

11. Writing the questions and/or the answers and taking it out is strictly prohibited.

12. Do not forget to submit your question booklet and answer sheet before leaving the exam room.